

# MST-02MH00-C0200U



MST, Fiber Optic Multiport Service Terminal, 2-port, long 2xN port, armored round loose tube cable, 200 ft

- Hardened connectors are factory-terminated and environmentally sealed for use in optical drop cable deployments
- Plug-and-play adapter ports ensure rapid cable installment in the outside plant access section of the network
- Multiport Service Terminals incorporate hardened connector technology that is designed to withstand the rugged outside plant environment

## Product Classification

<b>Product Type</b>	Access terminal, without splitter/tap
<b>Product Series</b>	MST
<b>Regional Availability</b>	Asia   Latin America   North America

## General Specifications

<b>Distribution Type</b>	2 ports
<b>Port, quantity</b>	2
<b>Cable Type</b>	Armored - Round - Loose Tube
<b>Port Type</b>	Hardened full-size SC/APC
<b>Stub Type</b>	Stub tail
<b>Cable, quantity</b>	1
<b>Enclosure Color</b>	Black
<b>Includes</b>	Enclosure (1)   Universal mounting bracket (1)
<b>Package, quantity</b>	1
<b>Packaging Type</b>	Box   Carton
<b>Splitter, quantity</b>	0

## Dimensions

<b>Cable Length</b>	60.96 m   200.00 ft
<b>Depth</b>	84.10 mm   3.31 in
<b>Height</b>	282.40 mm   11.12 in
<b>Outer Cable Dimensions</b>	4.4 x 7.4 mm (1.73 x 0.29 in)
<b>Weight, without cable</b>	0.86 kg   1.90 lb
<b>Width</b>	129.50 mm   5.10 in

## Dimension Drawing

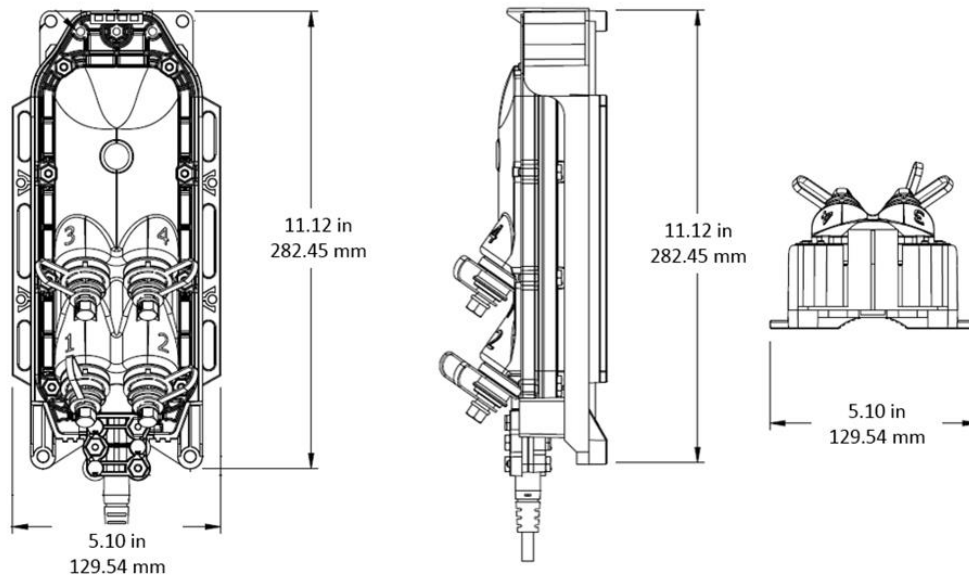

## Mechanical Specifications

**Enclosure Material Type**

Gasketed hardened plastic

**Mount Type**

Handhole | Pedestal | Pole | Strand

## Optical Specifications

**Attenuation at Length, maximum**

0.30 dB/km @ 1550 nm | 0.40 dB/km @ 1310 nm

**Directivity, minimum**

60 dB

**Fiber Type**

G.657.A2

**Insertion Loss, Terminal Connector, maximum**

0.40 dB

**Insertion Loss, Terminal Connector, typical**

0.16 dB

**Return Loss, Connector, minimum**

65 dB

**Wavelength Range**

1260–1635 nm

## Environmental Specifications

**Environmental Space**

Above ground | Below ground | Buried

**Flammability Rating**

UL 94 5VA

**Operating Temperature**

-40 °C to +70 °C (-40 °F to +158 °F)

**Qualification Standard**

IEC 60529, IP68 + 2 m waterhead | Telcordia GR-3120-CORE | Telcordia GR-326-CORE | Telcordia GR-771-CORE

**Relative Humidity**

5%–95%, non-condensing

**UV Resistance**

UV stabilized

# MST-02MH00-C0200U

---

## Regulatory Compliance/Certifications

**Agency**

RoHS 2011/65/EU

ISO 9001:2015

**Classification**

Compliant

Designed, manufactured and/or distributed under this quality management system



## Included Products

MST-UMB-0204 — DLX® MST, Fiber Optic Universal Mounting Bracket, 2/4 port