

MST-06MH00-B2000U



MST, Fiber Optic Multiport Service Terminal, 6-port, long 2xN port, locatable flat loose tube cable, 2000 ft

- Hardened connectors are factory-terminated and environmentally sealed for use in optical drop cable deployments
- Plug and play adapter ports ensure rapid cable installment in the outside plant access section of the network
- Multiport Service Terminals incorporate hardened connector technology that is designed to withstand the rugged outside plant environment

Alternative products available:

HST-B6HNB2000NN000 HST, NOVUX™ Hardened Standard Terminal, 6-port, Flat toneable loose tube cable, 2000 ft/609 m

Product Classification

Regional Availability	Asia Latin America North America
Product Type	Access terminal, without splitter/tap
Product Series	MST

General Specifications

Cable Type	Locatable - Flat - Loose Tube
Cable, quantity	1
Distribution Type	6 ports
Enclosure Color	Black
Mounting	Handhole Pedestal Pole Strand
Port Type	Hardened full-size SC/APC
Port, quantity	6
Splitter, quantity	0
Stub Type	Stub tail

Dimensions

Height	414.5 mm 16.319 in
Width	129.5 mm 5.098 in
Depth	84.1 mm 3.311 in

MST-06MH00-B2000U

Cable Length, stub	2000 ft (609 m)
Cable Outer Diameter	5.0 mm (0.20 in)

Dimension Drawing



Ordering Tree

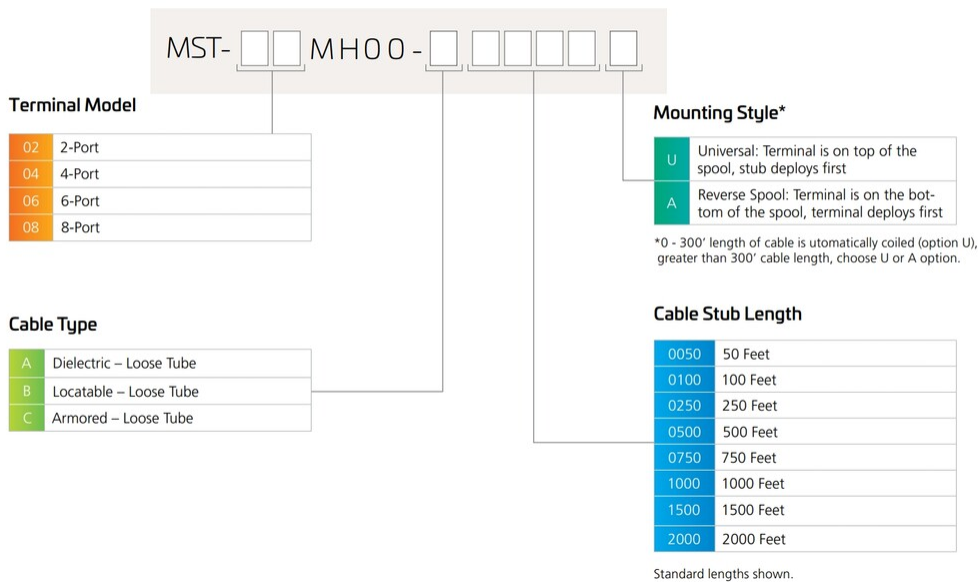

Material Specifications

Enclosure Material Type	Gasketed hardened plastic
--------------------------------	---------------------------

MST-06MH00-B2000U

Optical Specifications

Fiber Type	G.657.A1/A2
Operating Wavelength Range	1260 – 1635 nm
Attenuation Cable Coefficient, maximum	0.30 dB/km @ 1550 nm 0.40 dB/km @ 1310 nm
Attenuation Terminal Connectors, maximum	0.4 dB
Directivity, minimum	60 dB
Insertion Loss, Terminal Connector, typical	0.16 dB
Return Loss, Connector, minimum	65 dB

Environmental Specifications

Operating Temperature	-40 °C to +70 °C (-40 °F to +158 °F)
Relative Humidity	5%–100%, condensing
Environmental Space	Above ground Below ground Buried
Flammability Rating	UL 94 5VA
Qualification Standards	IEC 60529, IP68 + 2 m waterhead Telcordia GR-3120-CORE Telcordia GR-326-CORE Telcordia GR-771-CORE
UV Resistance	UV stabilized

Packaging and Weights

Included	Enclosure (1) Universal mounting bracket (1)
Packaging quantity	1
Packaging Type	Box Carton
Weight, without cable	1.36 kg 2.998 lb

Regulatory Compliance/Certifications

Agency	Classification
CHINA-ROHS	Below maximum concentration value
ISO 9001:2015	Designed, manufactured and/or distributed under this quality management system
REACH-SVHC	Compliant as per SVHC revision on www.commscope.com/ProductCompliance
ROHS	Compliant
UK-ROHS	Compliant



MST-06MH00-B2000U

Included Products

- MST-UMB-0608 – DLX® MST, Fiber Optic Universal Mounting Bracket, 6/8 port

MST-UMB-0608

DLX® MST, Fiber Optic Universal Mounting Bracket, 6/8 port



Product Classification

Regional Availability	EMEA Latin America North America
Product Type	Mounting bracket
Product Series	MST

General Specifications

Color	Black
--------------	-------

Environmental Specifications

Environmental Space	Outdoor
----------------------------	---------

Packaging and Weights

Packaging quantity	1
Packaging Type	Bag Carton

Regulatory Compliance/Certifications

Agency	Classification
CHINA-ROHS	Below maximum concentration value
REACH-SVHC	Compliant as per SVHC revision on www.commscope.com/ProductCompliance
ROHS	Compliant
UK-ROHS	Compliant

