

F1P43A-PNMSM-10M-X



FSJ1P-50A SureFlex® Jumper with interface types N Male and SMA Male, 10 m

OBSOLETE

This product was discontinued on: November 20, 2019

Product Classification

Product Type	SureFlex® standard
Product Brand	HELIAX® SureFlex®
Product Series	FSJ1-50A

General Specifications

Attachment, Connector B	Field attachment
Body Style, Connector A	Straight
Body Style, Connector B	Straight
Interface, Connector A	N Male
Interface, Connector B	SMA Male
Specification Sheet Revision Level	A

Dimensions

Length	10 m 32.808 ft
Nominal Size	1/4 in

Electrical Specifications

DTF, Connector A	-28 dB
DTF, Connector B	-28 dB

VSWR/Return Loss

Frequency Band	VSWR	Return Loss (dB)
800–970 MHz	1.151	23.07
1420–1530 MHz	1.151	23.07
1700–2180 MHz	1.151	23.07

F1P43A-PNMSM-10M-X

Jumper Assembly Sample Label



Environmental Specifications

Immersion Test Method

Meets IEC 60529:2001, IP68 in mated condition

Regulatory Compliance/Certifications

Agency

ISO 9001:2015

Classification

Designed, manufactured and/or distributed under this quality management system



Included Products

- F1TSM-C – SMA Male for 1/4 in FSJ1-50A cable

F1TSM-C



SMA Male for 1/4 in FSJ1-50A cable

Product Classification

Product Type	Wireless and radiating connector
Product Brand	HELIAX®
Product Series	FSJ1-50A

General Specifications

Body Style	Straight
Cable Family	FSJ1-50A
Inner Contact Attachment Method	Captivated
Inner Contact Plating	Gold
Interface	SMA Male
Mounting Angle	Straight
Outer Contact Attachment Method	Self-clamping
Outer Contact Plating	Trimetal
Pressurizable	No

Dimensions

Height	14.22 mm 0.56 in
Width	14.22 mm 0.56 in
Length	36.58 mm 1.44 in
Diameter	14.22 mm 0.56 in
Nominal Size	1/4 in

Outline Drawing

F1TSM-C

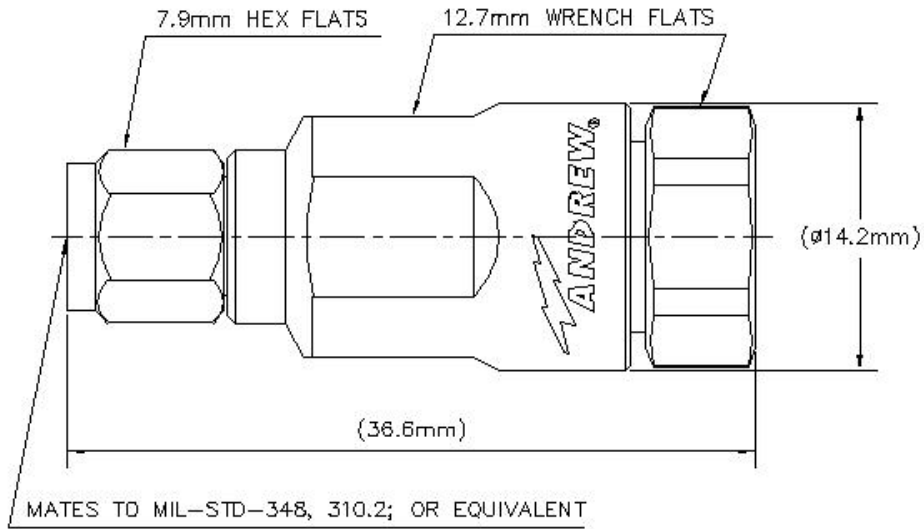

Electrical Specifications

Average Power at Frequency	0.4 kW @ 900 MHz
Cable Impedance	50 ohm
Connector Impedance	50 ohm
dc Test Voltage	1000 V
Inner Contact Resistance, maximum	3 mOhm
Insulation Resistance, minimum	5000 MOhm
Operating Frequency Band	0 – 6000 MHz
Outer Contact Resistance, maximum	2.5 mOhm
Peak Power, maximum	5 kW
RF Operating Voltage, maximum (vrms)	500 V
Shielding Effectiveness	-110 dB

VSWR/Return Loss

Frequency Band	VSWR	Return Loss (dB)
0–3000 MHz	1.173	21.98
3000–6000 MHz	1.222	20.01
6000–9000 MHz	1.29	18

Mechanical Specifications

F1TSM-C

Connector Retention Tensile Force	449.27 N 101 lbf
Coupling Nut Proof Torque	1.7 N-m 15.046 in lb
Coupling Nut Proof Torque Method	IEC 61169-16:9.3.11
Coupling Nut Retention Force	266.98 N 60.02 lbf
Coupling Nut Retention Force Method	IEC 61169-15:9.3.11
Insertion Force	97.86 N 22 lbf
Insertion Force Method	IEC 61169-16:9.3.5
Interface Durability	500 cycles
Interface Durability Method	IEC 61169-4:17
Mechanical Shock Test Method	IEC 60068-2-27

Environmental Specifications

Operating Temperature	-55 °C to +85 °C (-67 °F to +185 °F)
Storage Temperature	-65 °C to +125 °C (-85 °F to +257 °F)
Attenuation, Ambient Temperature	20 °C 68 °F
Average Power, Ambient Temperature	40 °C 104 °F
Average Power, Inner Conductor Temperature	100 °C 212 °F
Corrosion Test Method	IEC 60068-2-11
Moisture Resistance Test Method	IEC 60068-2-3
Thermal Shock Test Method	IEC 60068-2-14
Vibration Test Method	IEC 60068-2-6

Packaging and Weights

Weight, net	24.99 g 0.055 lb
--------------------	--------------------

Regulatory Compliance/Certifications

Agency	Classification
CHINA-ROHS	Below maximum concentration value
ISO 9001:2015	Designed, manufactured and/or distributed under this quality management system
REACH-SVHC	Compliant as per SVHC revision on www.commscope.com/ProductCompliance
ROHS	Compliant
UK-ROHS	Compliant/Exempted

FITSM-C

