

Grounding Kits

for HELIAX® Elliptical Waveguide and Coaxial Cable

Juegos de Conexión a Tierra

para la guía de ondas elíptica y cable coaxil HELIAX®

Kits de mise à la terre

pour guide d'ondes elliptique et câble coaxial HELIAX®

Erdungsschelle

für elliptische HELIAX®-Hohlleiter und Koaxialkabel

Kits de aterramento

para guia de ondas elíptico e cabos coaxiais HELIAX®

HELIAX® 橢圓形波導管與同軸電纜的接
地元件

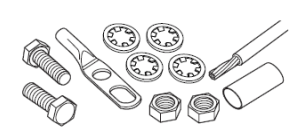
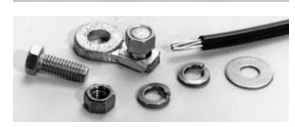
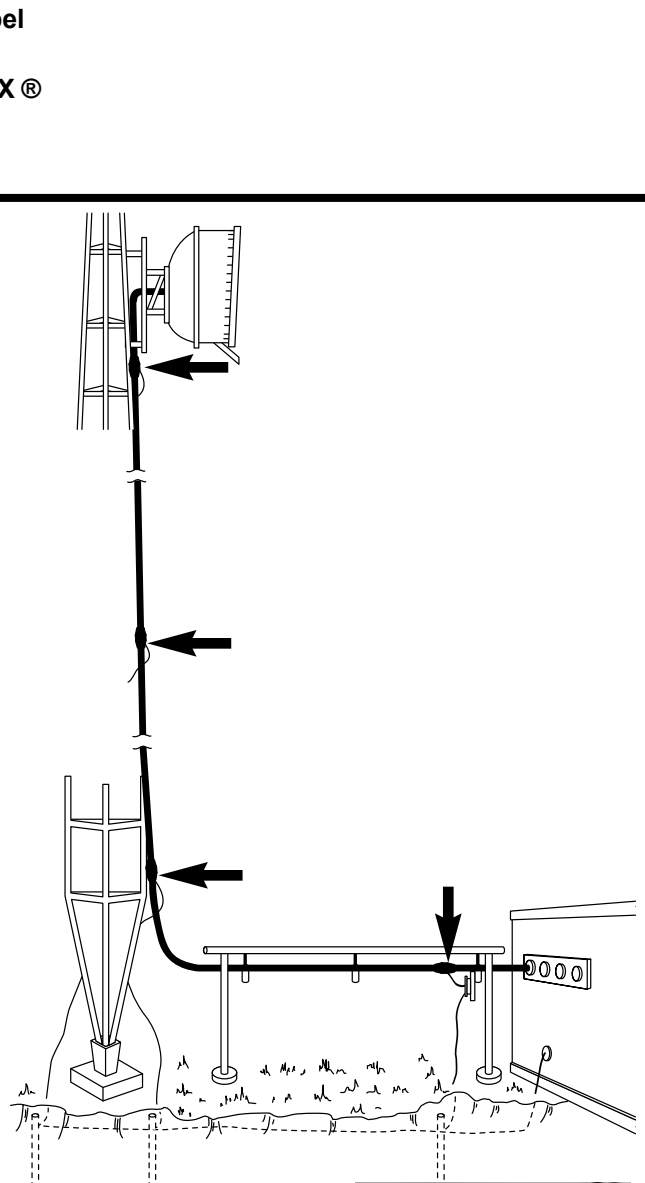
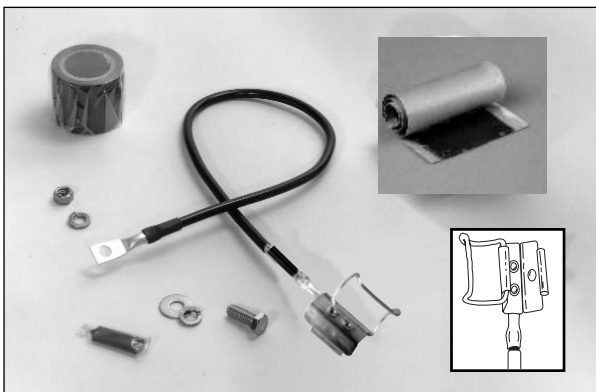
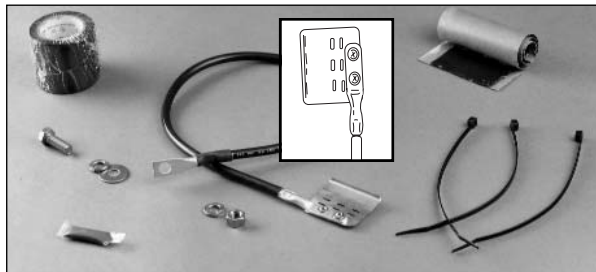
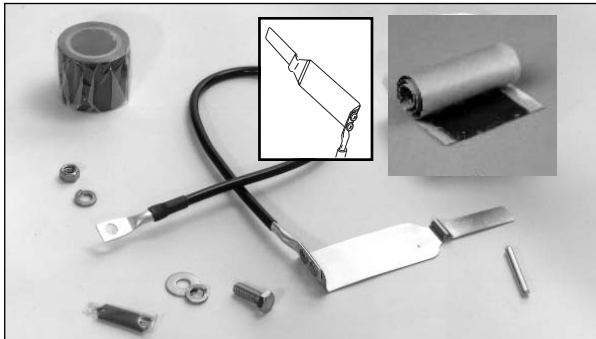

Note: Hardware kit may contain split lock washers or internal tooth lock washers as illustrated here.

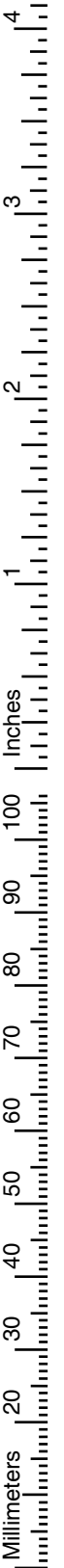

⚠ WARNING

Do not attempt grounding kit installation in the presence of thunderstorms. Failure to obey this warning may result in injury or death to you or to others.

⚠ ADVERTENCIA

No intente a instalar el kit de tierra durante una tormenta. El resultado de no obedecer esta advertencia puede causar la muerte a usted o a otros.

⚠ AVERTISSEMENT

Ne tentez aucune installation du kit de mise à la terre en cas d'orage. Le non-respect de cet avertissement peut engendrer des blessures ou la mort de l'utilisateur ou d'autres personnes.

⚠ WARNUNG!

Erden Sie den fertig montierten Bausatz keinesfalls bei einem Gewitter. Nichtbeachtung kann zu Verletzung oder Tod führen.

⚠ ADVISO

Nao tente aterrar o kit de instalação durante tempestades. Pode provocar dano físico ou morte a você ou a terceiros.

⚠ 警告

不要試圖在有雷雨時安裝接地元件。
不遵守該警告可能會對你和其他人造成傷害或死亡。

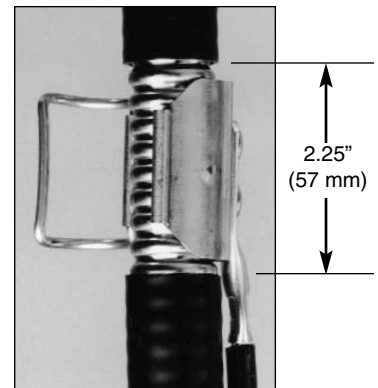
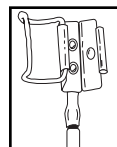
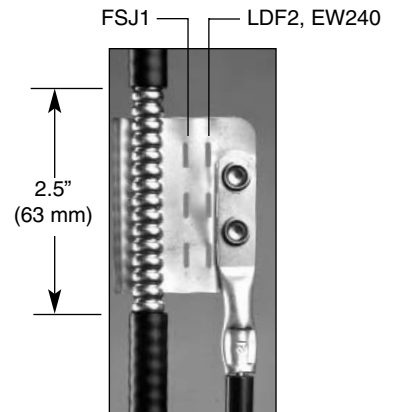
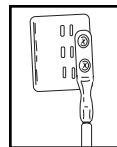
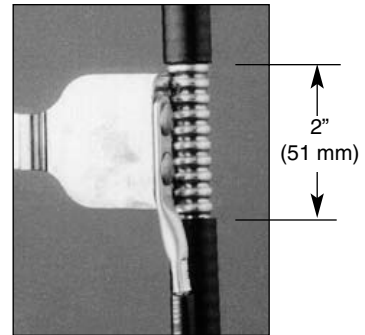
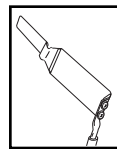
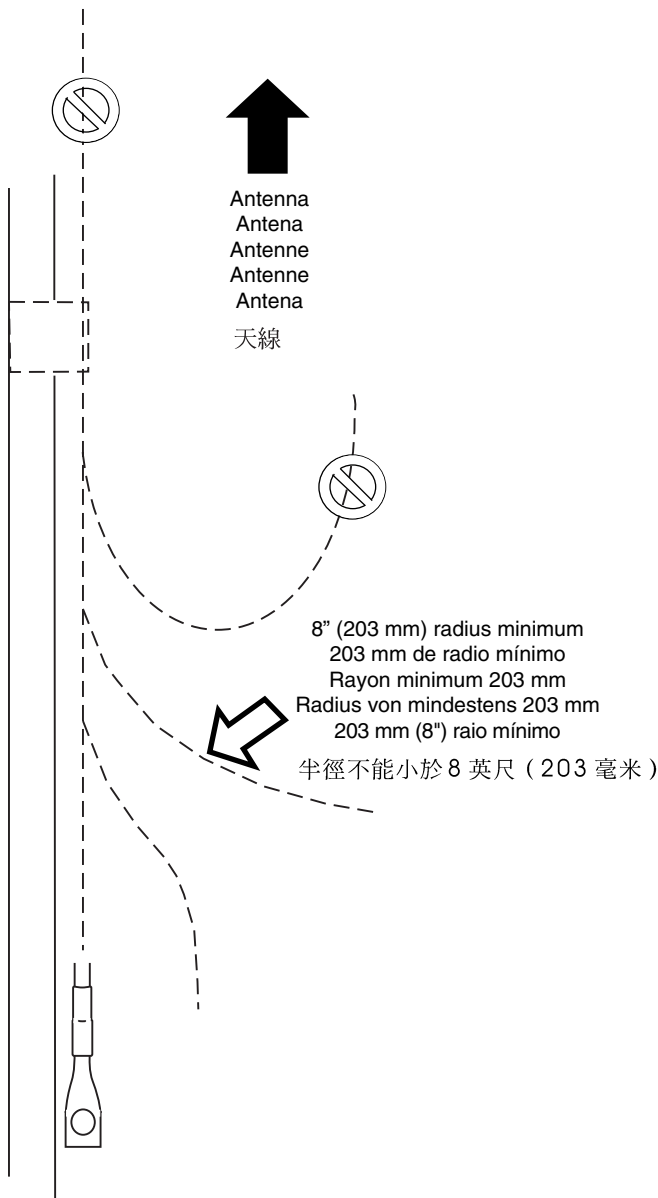

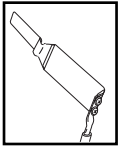

1-1/2" x 2-1/2"
(38 x 63.5 mm)

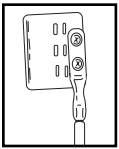
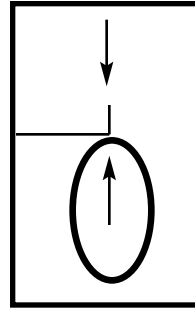

1-1/2" x 2-1/2"
(38 x 63.5 mm)

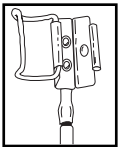
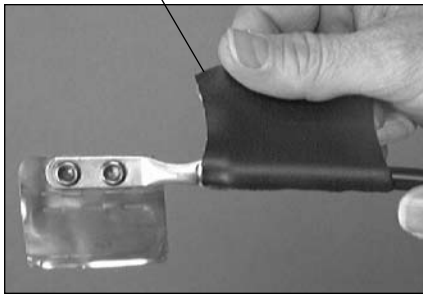

1-1/2" x 2-1/2"
(38 x 63.5 mm)

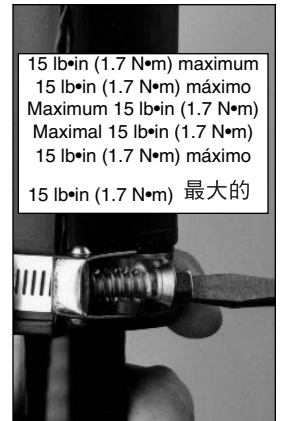
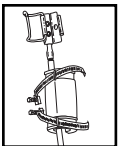
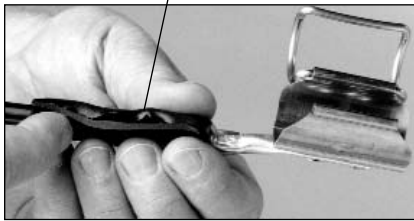

15 lb•in (1.7 N•m) maximum
15 lb•in (1.7 N•m) máximo
Maximum 15 lb•in (1.7 N•m)
Maximal 15 lb•in (1.7 N•m)
15 lb•in (1.7 N•m) máximo
15 lb•in (1.7 N•m) 最大的

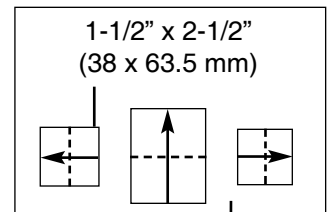
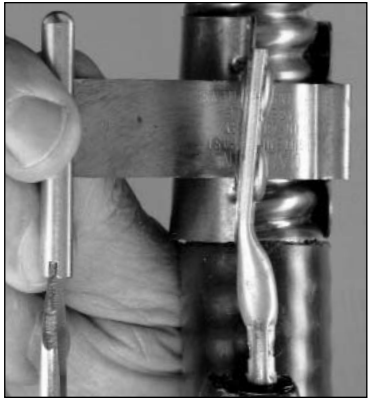
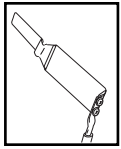

Stop tightening
Deje de apretar
Arrêter de serrer
Aufhören festzuziehen
Pare de apertar
停止緊固

Overtightened
Demasiado apretada
Surserré
Zu stark festgezogen
Aperte demais
過度緊固

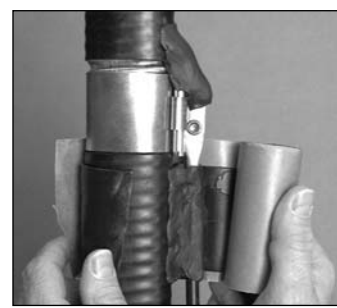
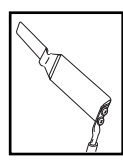
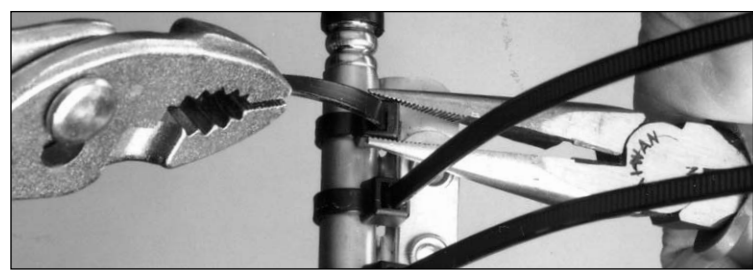
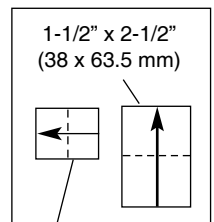
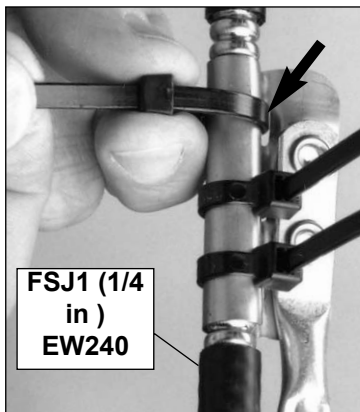
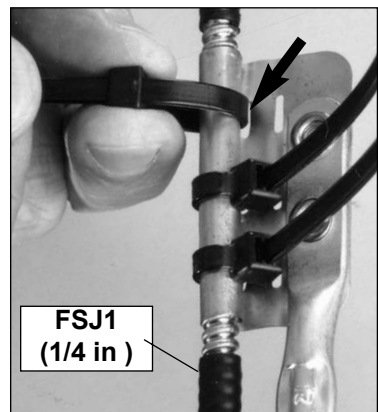
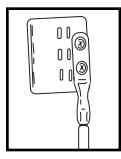

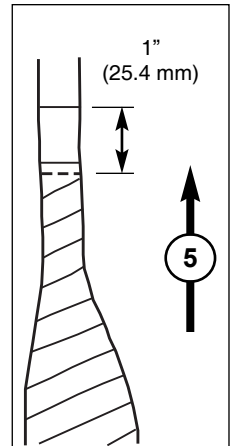
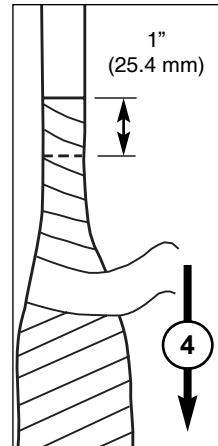
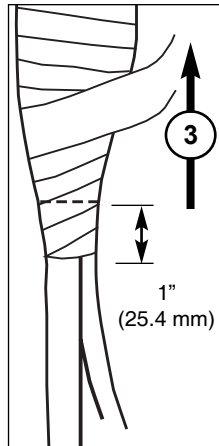
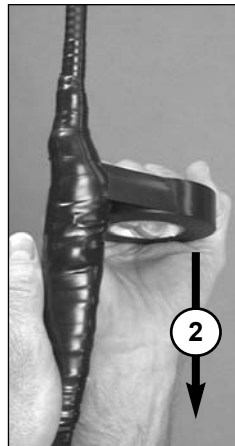
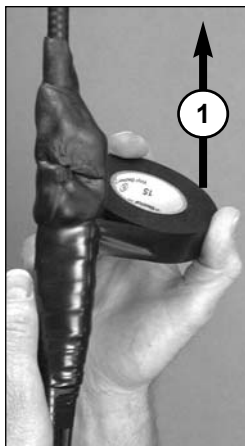
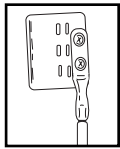
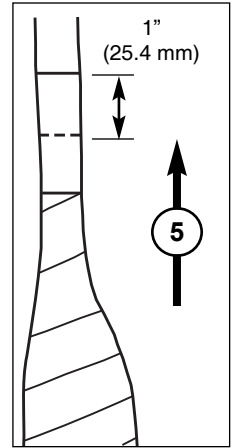
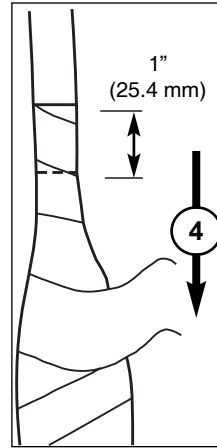
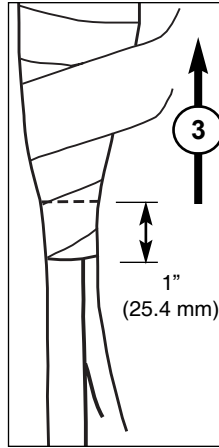
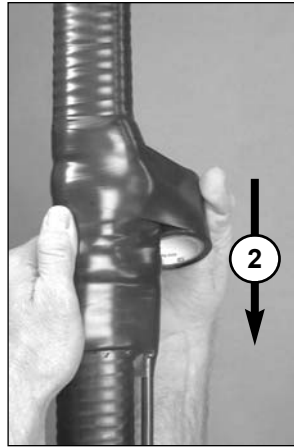
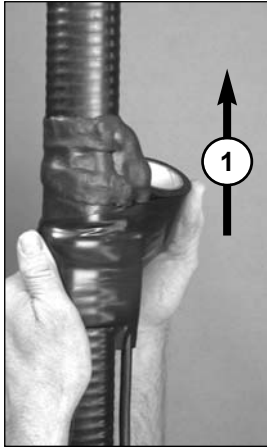
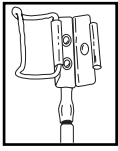

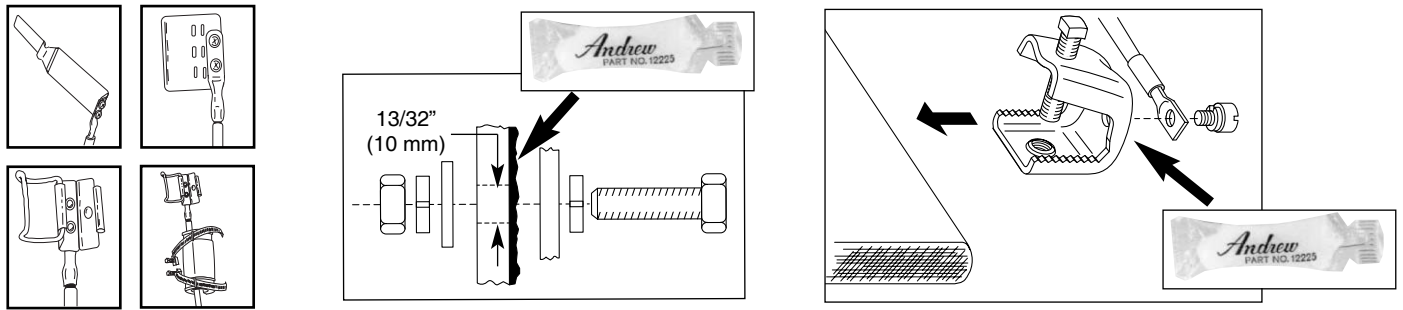
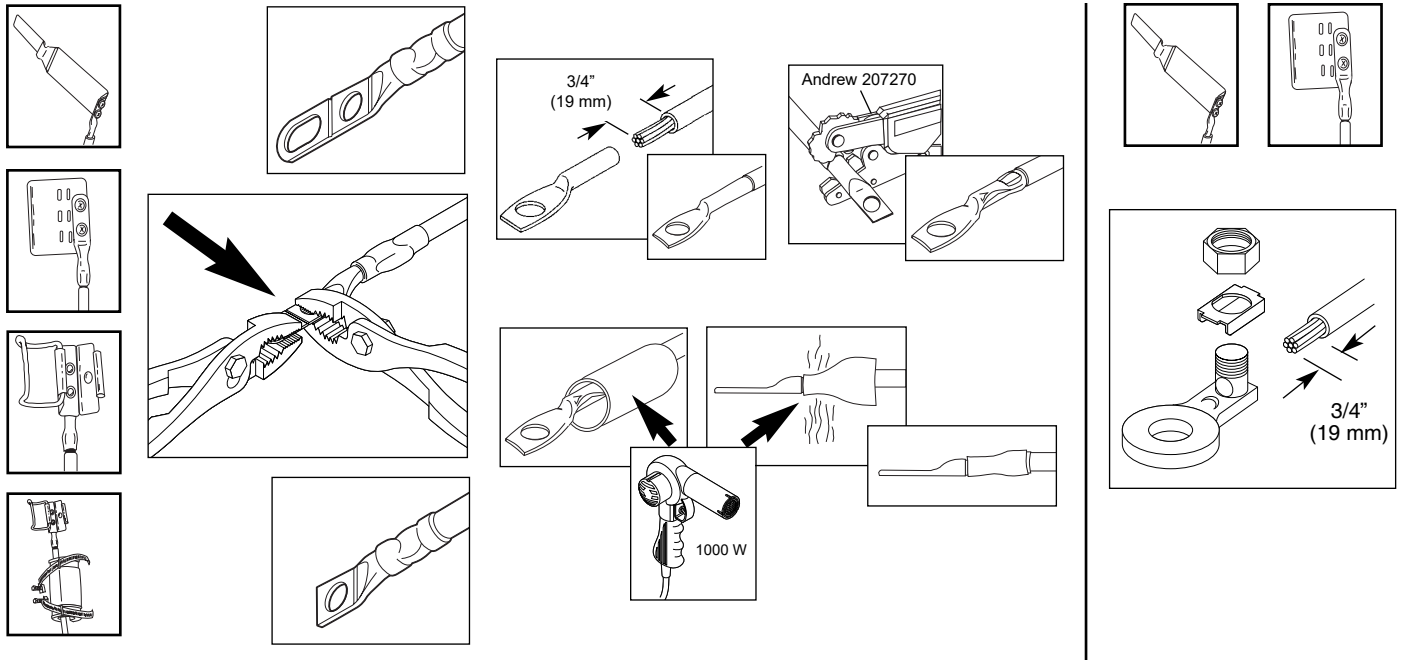

Notice

The installation, maintenance, or removal of antenna systems requires qualified, experienced personnel. Andrew installation instructions are written for such personnel. Antenna systems should be inspected once a year by qualified personnel to verify proper installation, maintenance, and condition of equipment.

Andrew disclaims any liability or responsibility for the results of improper or unsafe installation practices.

Advertencia

Se requiere que la instalación, el mantenimiento o el retiro de los sistemas de antenas sea efectuado por personal calificado y con experiencia. Las instrucciones de instalación de Andrew se han escrito pensando en esta clase de personal. Se deben inspeccionar los sistemas de antenas una vez al año utilizando personal calificado a fin de verificar si la instalación, el mantenimiento y la condición del equipo son adecuados.

Andrew no asume ninguna responsabilidad ni obligación resultante de las prácticas de instalación o inseguras.

Avis

L'installation, la maintenance et la dépose des systèmes d'antennes doivent être effectuées par des techniciens qualifiés. Les instructions de montage Andrew ont été prévues pour un tel personnel. Les systèmes d'antennes doivent être inspectés tous les ans par des techniciens qualifiés afin de vérifier l'installation, la maintenance et l'état des équipements.

Andrew décline toute responsabilité dans le cas de non respect de ces instructions.

Anmerkung

Die Installation, Wartung oder Abnahme eines Antennensystems erfordert qualifiziertes und geschultes Personal, für das auch die Andrew Montageanweisungen geschrieben worden sind. Antennensysteme sollten jährlich von qualifiziertem Personal überprüft werden, um die einwandfreie Montage, Wartung und den Zustand der Systemkomponenten sicherzustellen.

Andrew lehnt jede Haftung oder Verantwortung für Schäden ab, die aufgrund unsachgemäßer Installation auftreten.

Atenção

A instalação, manutenção ou remoção dos sistemas de antena requer pessoal experiente e qualificado. As instruções de instalação da Andrew foram escritas para estas pessoas. Os sistemas de antena, devem ser inspecionados pelo pessoal qualificado, uma vez por ano, para verificar a instalação e manutenção adequadas e as condições do equipamento.

A Andrew não se responsabiliza por resultados advindos de práticas de instalação inadequadas ou inseguras.

注意：天線系統的安裝、維護與拆卸，必須由有經驗的合格技術人員進行。Andrew 安裝指示是專為該技術人員所編寫的。天線系統每年必須由合格的技術人員檢查一次，以確保設備的安裝、保養及狀況良好。Andrew 公司申明對於不恰當或不安全的安裝所導致的後果，一概不負任何義務和責任。

ANDREW an Amphenol company

2601 Telecom Parkway, Richardson, Texas, 75082, USA
www.andrew.com

Notice: ANDREW disclaims any liability or responsibility for the results of improper or unsafe installation, inspection, maintenance, or removal practices.

Aviso: ANDREW no acepta ninguna obligación ni responsabilidad como resultado de prácticas incorrectas o peligrosas de instalación, inspección, mantenimiento o retiro.

Avis: ANDREW décline toute responsabilité pour les conséquences de procédures d'installation, d'inspection, d'entretien ou de retrait incorrectes ou dangereuses.

Hinweis: ANDREW lehnt jede Haftung oder Verantwortung für Schäden ab, die aufgrund unsachgemäßer Installation, Überprüfung, Wartung oder Demontage auftreten.

Atenção: A ANDREW abdica do direito de toda responsabilidade pelos resultados de práticas inadequadas e sem segurança de instalação, inspeção, manutenção ou remoção.

Avvertenza: ANDREW declina eventuali responsabilità derivanti dall'esecuzione di procedure di installazione, ispezione, manutenzione e smontaggio improprie o poco sicure.

注意：ANDREW 公司申明對於不恰當或不安全的安裝、檢驗、維修或拆卸操作所導致的後果不負任何義務和責任

©2025 ANDREW, an Amphenol company. All rights reserved. Amphenol and ANDREW are registered trademarks of Amphenol and/or its affiliates in the U.S. and other countries. All product names, trademarks and registered trademarks are property of their respective owners.