

E16V90P49



Twin Quadplexer, dc bypass on port 4, with 4.3-10 connectors

- Industry leading PIM performance
- Twin configuration
- New 4.3-10 connectors for improved PIM performance and size reduction
- Suitable for feeders cables reduction

Product Classification

Product Type Quadplexer

General Specifications

Product Family CBC7182126

Color Gray

Modularity 2-Twin

Mounting Pole | Wall

Mounting Pipe Hardware Band clamps (2)

RF Connector Interface 4.3-10 Female

RF Connector Interface Body Style Medium neck

Dimensions

Height 210 mm | 8.268 in

Width 250 mm | 9.843 in

Depth 141 mm | 5.551 in

Mounting Pipe Diameter Range 42.6–122 mm

Outline Drawing

E16V90P49

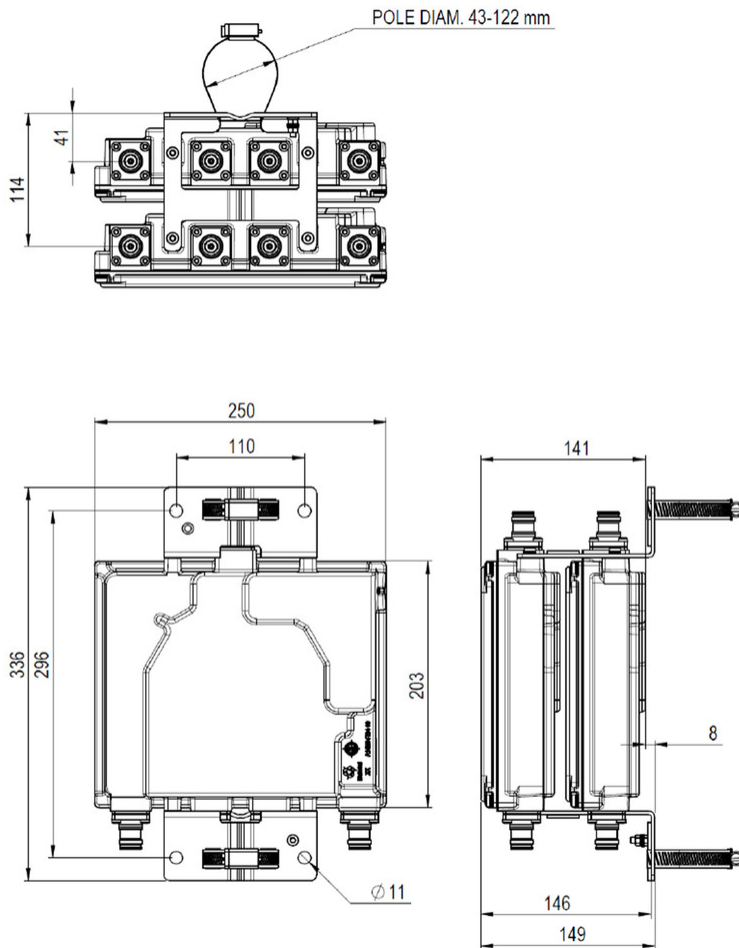

Electrical Specifications

Impedance

50 ohm

License Band, Band Pass

APT 700 | CEL 850 | CEL 900 | DCS 1800 | EDD 800 | IMT 2100 | IMT 2600 | LMR 800 | LMR 900

Electrical Specifications, dc Power/Alarm

dc/AISG Pass-through, combiner

Branch 4

dc/AISG Pass-through, demultiplexer

Branch 4

Lightning Surge Current

5 kA

Lightning Surge Current Waveform

8/20 waveform

Electrical Specifications, AISG

AISG Carrier

2176 KHz \pm 100 ppm

E16V90P49

Insertion Loss, maximum	0.5 dB
Return Loss, minimum	10 dB

Electrical Specifications

Sub-module	1 2	1 2	1 2	1 2
Branch	1	2	3	4
Port Designation	PORT 1 698-960	PORT 2 1710-1880	PORT 3 1920-2170	PORT 4 2300-2690
License Band	APT 700, Band Pass CEL 850, Band Pass CEL 900, Band Pass EDD 800, Band Pass LMR 800, Band Pass LMR 900, Band Pass		DCS 1800, Band Pass	IMT 2100, Band Pass IMT 2600, Band Pass

Electrical Specifications, Band Pass

Frequency Range, MHz	698–960	1710–1880	1920–2170	2300–2690
Insertion Loss, typical, dB	0.1	0.2	0.2	0.15
Return Loss, minimum, dB	18	18	18	18
Return Loss, typical, dB	20	20	20	20
Isolation, minimum, dB	50	50	50	50
Input Power, RMS, maximum, W	300	300	300	200
3rd Order PIM, typical, dBc	-160	-160	-160	-160
3rd Order PIM Test Method	Two +43 dBm carriers	Two +43 dBm carriers	Two +43 dBm carriers	Two +43 dBm carriers

Block Diagram

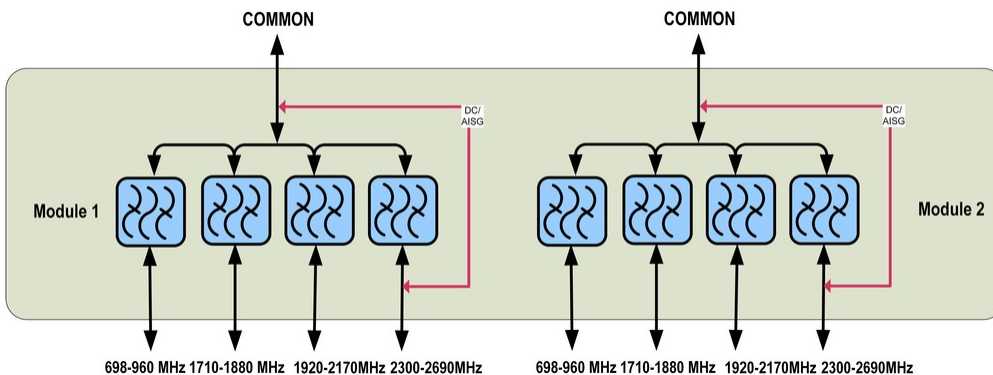

Mechanical Specifications

Wind Speed, maximum	216 km/h (134 mph)
----------------------------	--------------------

E16V90P49

Environmental Specifications

Operating Temperature	-40 °C to +65 °C (-40 °F to +149 °F)
Relative Humidity	15%–100%
Corrosion Test Method	IEC 60068-2-11, 30 days
Ingress Protection Test Method	IEC 60529:2001, IP67
Vibration Test Method	IEC 60068-2-6

Packaging and Weights

Included	Mounting hardware
Weight, net	10 kg 22.046 lb