

VHLPX2-7W-3WH/D



0.6m | 2ft ValuLine High Performance Antenna, dual polarized, 7.100 – 8.500 GHz, UBR84 Flange, White Antenna, Grey Radome

Product Classification

Product Type	Microwave antenna
Product Brand	ValuLine®

General Specifications

Antenna Type	VHLPX - ValuLine® High Performance Low Profile Antenna, dual-polarized
Polarization	Dual
Antenna Input	UBR84
Antenna Color	White
Reflector Construction	One-piece reflector
Radome Color	Gray
Radome Material	Composite Broadband
Flash Included	No
Side Struts, Included	0
Side Struts, Optional	0

Dimensions

Diameter, nominal	0.6 m 2 ft
--------------------------	--------------

Electrical Specifications

Operating Frequency Band	7.100 – 8.500 GHz
Gain, Low Band	29.6 dBi
Gain, Mid Band	31.1 dBi
Gain, Top Band	32.2 dBi
Boresite Cross Polarization Discrimination (XPD)	32 dB
Front-to-Back Ratio	57 dB
Beamwidth, Horizontal	4.7 °

VHLPX2-7W-3WH/D

Beamwidth, Vertical	4.7 °
Return Loss	17.7 dB
VSWR	1.3
Radiation Pattern Envelope Reference (RPE)	7211D
Electrical Compliance	ACMA FX03_7p5b Brazil Anatel Class 3 ETSI 302 217 Class 3

Mechanical Specifications

Compatible Mounting Pipe Diameter	48 mm–120 mm 1.9 in–4.7 in
Fine Azimuth Adjustment Range	±15°
Fine Elevation Adjustment Range	±15°
Wind Speed, operational	180 km/h 111.847 mph
Wind Speed, survival	252 km/h 156.585 mph

Antenna Dimensions and Mounting Information

VHLPX2-7W-3WH/D

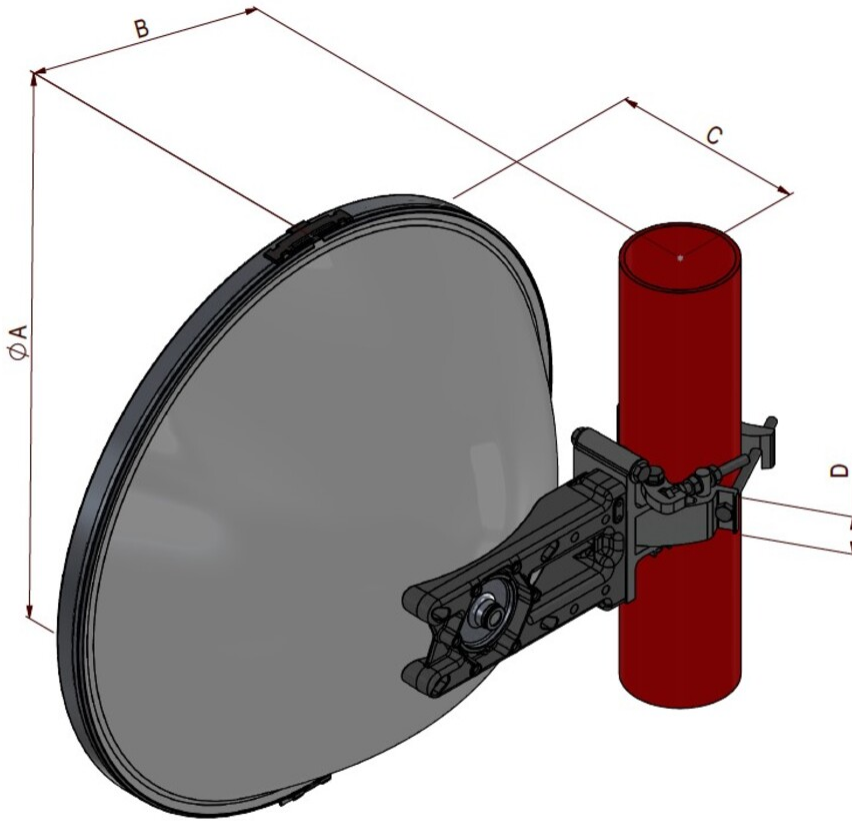

Dimensions in Inches (mm)				
Antenna Size, ft (m)	A	B	C	D
2 (0.6)	25.9 (660)	12.2 (310)	8.9 (228)	1.8 (45)

Wind Forces at Wind Velocity Survival Rating

Axial Force (FA)	1400 N 314.733 lbf
Angle α for MT Max	-50 °
Side Force (FS)	-350 N -78.683 lbf
Twisting Moment (MT)	500 N-m 4,425.373 in lb
Zcg without Ice	55 mm 2.165 in
Zcg with 1 in (25 mm) Radial Ice	91 mm 3.583 in
Weight with 1 in (25 mm) Radial Ice	20 kg 44.092 lb

Wind Forces at Wind Velocity Survival Rating Image

VHLPX2-7W-3WH/D

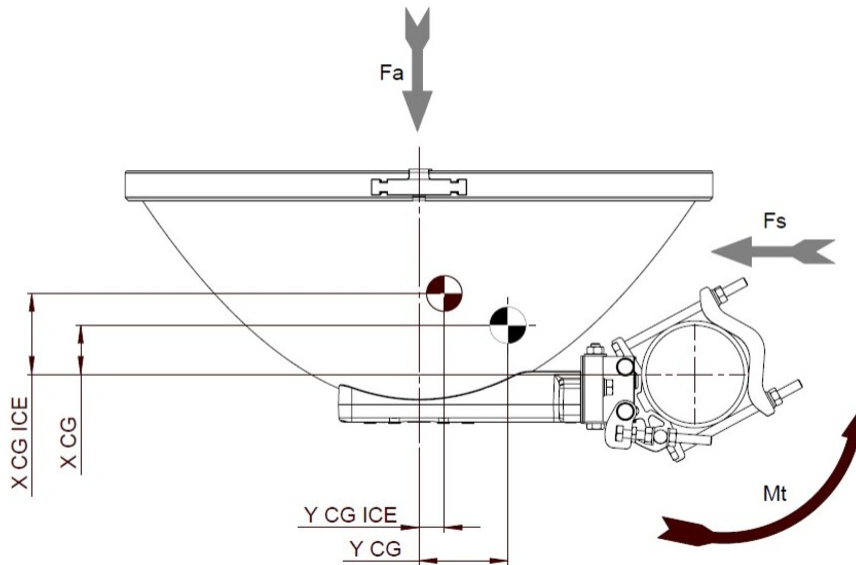

Packaging and Weights

Height, packed	329 mm 12.953 in
Width, packed	729 mm 28.701 in
Length, packed	697 mm 27.441 in
Packaging Type	Standard pack
Volume	0.17 m ³ 6.003 ft ³
Weight, gross	9.8 kg 21.605 lb
Weight, net	6.7 kg 14.771 lb

Regulatory Compliance/Certifications

Agency	Classification
ISO 9001:2015	Designed, manufactured and/or distributed under this quality management system

* Footnotes

Operating Frequency Band	Bands correspond with CCIR recommendations or common allocations used throughout the world. Other ranges can be accommodated on special order.
Gain, Mid Band	For a given frequency band, gain is primarily a function of antenna size. The gain of Andrew antennas is determined by either gain by comparison or by computer integration of the measured antenna patterns.

VHLPX2-7W-3WH/D

Boresite Cross Polarization Discrimination (XPD)	The difference between the peak of the co-polarized main beam and the maximum cross-polarized signal over an angle twice the 3 dB beamwidth of the co-polarized main beam.
Front-to-Back Ratio	Denotes highest radiation relative to the main beam, at $180^\circ \pm 40^\circ$, across the band. Production antennas do not exceed rated values by more than 2 dB unless stated otherwise.
Return Loss	The figure that indicates the proportion of radio waves incident upon the antenna that are rejected as a ratio of those that are accepted.
VSWR	Maximum; is the guaranteed Peak Voltage-Standing-Wave-Ratio within the operating band.
Radiation Pattern Envelope Reference (RPE)	Radiation patterns define an antenna's ability to discriminate against unwanted signals. Under still dry conditions, production antennas will not have any peak exceeding the current RPE by more than 3dB, maintaining an angular accuracy of $\pm 1^\circ$ throughout
Wind Speed, operational	For VHLP(X), SHP(X), HX and USX antennas, the wind speed where the maximum antenna deflection is 0.3 x the 3 dB beam width of the antenna. For other antennas, it is defined as a deflection is equal to or less than 0.1 degrees.
Wind Speed, survival	The maximum wind speed the antenna, including mounts and radomes, where applicable, will withstand without permanent deformation. Realignment may be required. This wind speed is applicable to antenna with the specified amount of radial ice.
Axial Force (FA)	Maximum forces exerted on a supporting structure as a result of wind from the most critical direction for this parameter. The individual maximums specified may not occur simultaneously. All forces are referenced to the mounting pipe.
Side Force (FS)	Maximum side force exerted on the mounting pipe as a result of wind from the most critical direction for this parameter. The individual maximums specified may not occur simultaneously. All forces are referenced to the mounting pipe.
Twisting Moment (MT)	Maximum forces exerted on a supporting structure as a result of wind from the most critical direction for this parameter. The individual maximums specified may not occur simultaneously. All forces are referenced to the mounting pipe.
Packaging Type	Andrew standard packing is suitable for export. Antennas are shipped as standard in totally recyclable cardboard or wire-bound crates (dependent on product). For your convenience, Andrew offers heavy duty export packing options.