

MATERIAL ID	DESCRIPTION
760249130	FP KT 4P LBL 262

NOTES:

- SEE COMMSCOPE CATALOG FOR PART NUMBER SUFFIXES TO INDICATE COLOR/PKG.
- SEE COMMSCOPE CATALOG FOR COMPLETE LIST OF PARTS RELATED TO THE USE OF THIS PRODUCT.
- DIMENSIONS IN PARENTHESES ARE IN METRIC[MM].
- PART INCLUDES:
 - (1) 4 PORT NAR LBL FP, WHITE
 - (2) SCREW

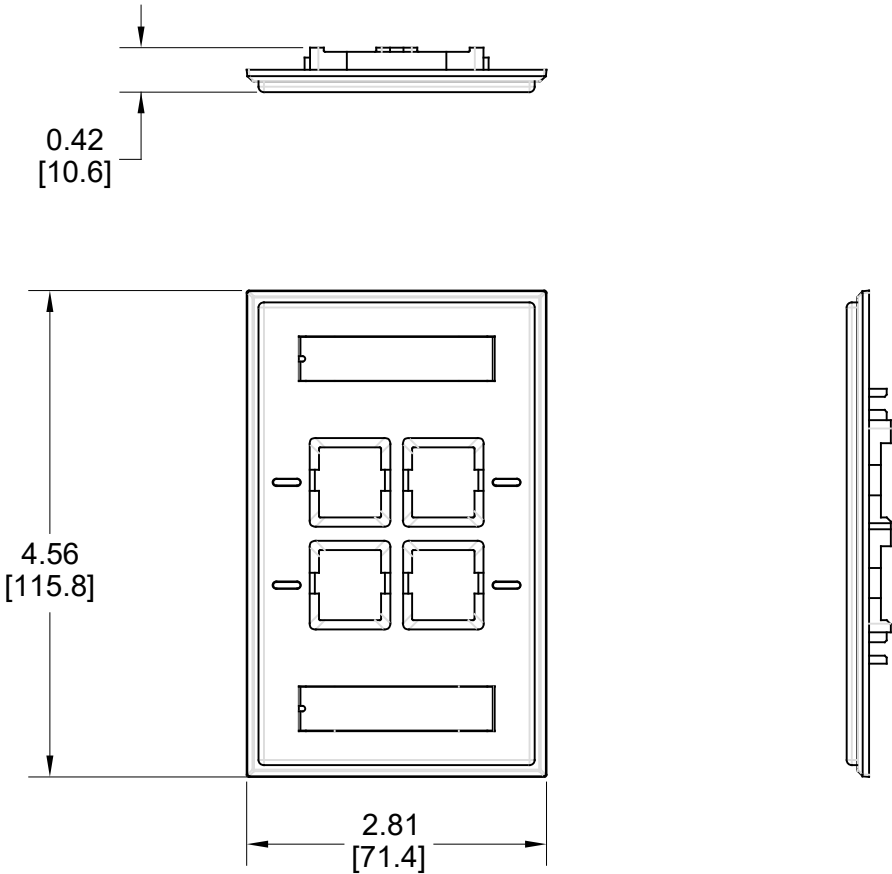

FP KT 4P LBL 262	
COMMSCOPE, INC OF NORTH CAROLINA	
DRAWN BY JW	
DATE 02/03/2021	DWG NO 760249130

REV	DATE	ECR	DESCRIPTION	APPROVED BY
1	02/03/21		INITIAL ISSUE	FW