

# HXT-B4AMA0750FU000



NOVUX™ Prodigy™ Hardened Indexing Terminal, 12 Fiber Multi-use 2F, two 1F Prodigy Adapter ports, 1 HMFOC Reverse port, Dielectric flat loose tube, 750 ft/228 m HMFOC Plug (female/no pin) tail, with mounting bracket

- NOVUX™ Hardened Multi-fiber Terminals incorporate hardened connector technology that is designed to withstand the rugged outside plant environment
- Hardened connectors are factory-integrated and environmentally sealed for use in optical drop cable deployments
- Plug-and-play adapter ports ensure rapid cable installment in the outside plant access section of the network
- NOVUX™ Prodigy™ HXT fiber indexing terminals are available with 1:4 or 1:8 splitter and optional multi-use ports, Index Only and Index Branching 2 to 6 fiber solutions
- Available stubless or with flat dielectric and flat toneable/locatable dielectric cable with HMFOC Plug (female/no pin)
- NOVUX™ Prodigy™ smaller terminal size for aesthetics and allowing installation in constrained spaces
- NOVUX™ Prodigy™ terminals are available in Black (RAL# 9005) or Gray (RAL# 7035)
- CommScope Product ID plate with QR code link to product documents and C-Track

## Product Classification

<b>Regional Availability</b>	Asia   EMEA   Latin America   North America
<b>Product Type</b>	Access terminal, without splitter/tap
<b>Product Brand</b>	NOVUX™
<b>Product Series</b>	HXT
<b>Minimum Order Quantity</b>	1

## General Specifications

<b>Cable Type</b>	Dielectric - Flat - Loose Tube
<b>Cable, quantity</b>	1
<b>Distribution Type</b>	12F multi-use 2F
<b>Drop Port Type</b>	Hardened Prodigy SC/APC
<b>Drop Port, quantity</b>	2
<b>Enclosure Color</b>	Black (RAL 9005)
<b>Forward Port Type</b>	Hardened multi-fiber (HMFOC) jack, male/pinned
<b>Forward Port, quantity</b>	1
<b>Mounting</b>	Handhole   Pedestal   Pole   Strand

# HXT-B4AMA0750FU000

<b>Port Type</b>	Hardened Prodigy SC/APC
<b>Port, quantity</b>	4
<b>Reverse Port Type</b>	Hardened multi-fiber (HMFOC) jack, male/pinned
<b>Reverse Port, quantity</b>	1
<b>Stub Type</b>	Hardened multi-fiber (HMFOC) plug, female/no pin

## Dimensions

<b>Height</b>	80 mm   3.14 in
<b>Width</b>	79 mm   3.11 in
<b>Length</b>	161 mm   6.33 in
<b>Cable Length, stub</b>	750 ft (228 m)
<b>Cable Outer Diameter</b>	4.3 x 8.0 mm (0.17 x 0.31 in) in

## Dimension Drawing

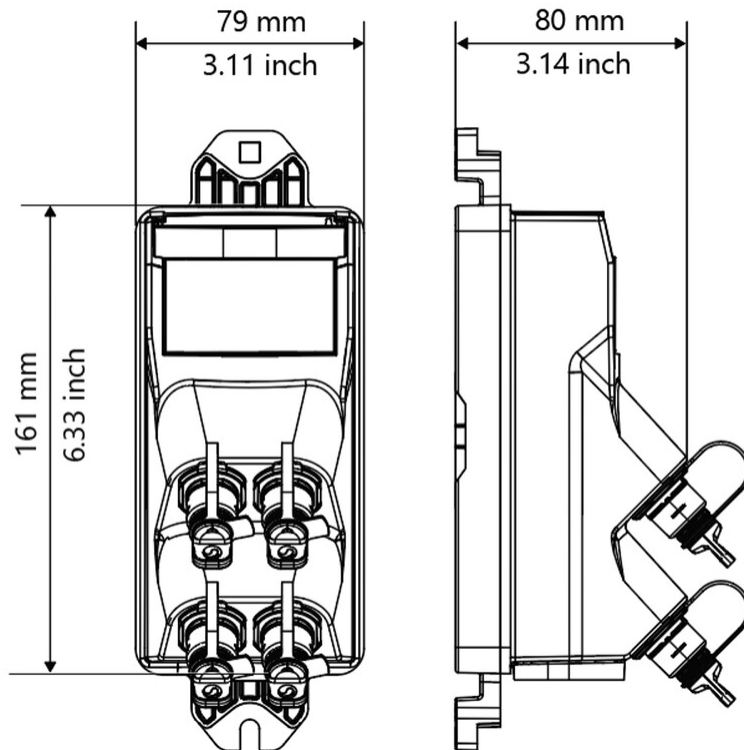

## Port Configuration

# HXT-B4AMA0750FU000

NOVUX HT	TECHNOLOGIES AVAILABLE	SMALL	MEDIUM	LARGE
HXT Series	Fiber indexing	12 fiber index only, 1f	12 fiber 1:4	12 fiber 1:8
		12 fiber index only, 2f	12f multi-use 2f + 1:4	12 fiber multi-use, 3f +1:4
		12 fiber index only, 3f	24f multi-use 2f	12 fiber multi-use, 4f +1:4
		12 fiber index only, 4f	24f multi-use 3f	12 fiber multi-use, 2f +1:8
		12 fiber multi-use, 2f	24f multi-use 4f	
		12 fiber branching, 2 to 6f per port		

## Ordering Tree



## Material Specifications

**Enclosure Material Type** Hardened plastic

## Optical Specifications

**Fiber Type** G.657.A1/A2

**Operating Wavelength Range** 1260 – 1635 nm

**Attenuation Single Ports, maximum** 0.4 dB

**Attenuation Cable Coefficient, maximum** 0.30 dB/km @ 1550 nm | 0.40 dB/km @ 1310 nm

**Insertion Loss, Stub Connector, maximum** 0.65 dB

**Return Loss, Connector, maximum** 65 dB

# HXT-B4AMA0750FU000

---

## Environmental Specifications

<b>Operating Temperature</b>	-40 °C to +65 °C (-40 °F to +149 °F)
<b>Relative Humidity</b>	5%–100%, condensing
<b>Environmental Space</b>	Above ground   Below ground
<b>Qualification Standards</b>	IEC 60529, IP68 + 2 m waterhead   IEC 61753-1, category G
<b>UV Resistance</b>	UV stabilized

## Packaging and Weights

<b>Included</b>	Universal mounting bracket
<b>Packaging quantity</b>	1
<b>Packaging Type</b>	Box   Universal spool, cardboard: terminal is on top of the spool, stub deploys first

## Regulatory Compliance/Certifications

<b>Agency</b>	<b>Classification</b>
CHINA-ROHS	Below maximum concentration value
ISO 9001:2015	Designed, manufactured and/or distributed under this quality management system
REACH-SVHC	Compliant as per SVHC revision on <a href="http://www.commscope.com/ProductCompliance">www.commscope.com/ProductCompliance</a>
ROHS	Compliant
UK-ROHS	Compliant

