

HXT-B9ARA2000FU000



NOVUX™ Prodigy™ Hardened Indexing Terminal, Prodigy Adapter ports, 12F, 1:4 Splitter, 1 HMFOC port, Three 1F multi-use, 1 Reverse HMFOC port, Dielectric flat loose tube, 2000 ft/610 m HMFOC Plug (female/no pin) tail, with mounting bracket

- NOVUX™ Hardened Multi-fiber Terminals incorporate hardened connector technology that is designed to withstand the rugged outside plant environment
- Hardened connectors are factory-integrated and environmentally sealed for use in optical drop cable deployments
- Plug-and-play adapter ports ensure rapid cable installment in the outside plant access section of the network
- NOVUX™ Prodigy™ HXT fiber indexing terminals are available with 1:4 or 1:8 splitter and optional multi-use ports, Index Only and Index Branching 2 to 6 fiber solutions
- Available stubless or with flat dielectric and flat toneable/locatable dielectric cable with HMFOC Plug (female/no pin)
- NOVUX™ Prodigy™ smaller terminal size for aesthetics and allowing installation in constrained spaces
- NOVUX™ Prodigy™ terminals are available in Black (RAL# 9005) or Gray (RAL# 7035)
- CommScope Product ID plate with QR code link to product documents and C-Track

Product Classification

Regional Availability	Asia EMEA Latin America North America
Product Type	Access terminal, with splitter/tap
Product Brand	NOVUX™
Product Series	HXT
Minimum Order Quantity	1

General Specifications

Cable Type	Dielectric - Flat - Loose Tube
Cable, quantity	1
Distribution Type	1 x 4 splitter + multi-use ports (3)
Drop Port Type	Hardened Prodigy SC/APC
Drop Port, quantity	6
Enclosure Color	Black (RAL 9005)
Forward Port Type	Hardened multi-fiber (HMFOC) jack, male/pinned
Forward Port, quantity	1
Mounting	Handhole Pedestal Pole Strand

HXT-B9ARA2000FU000

Port Type	Hardened Prodigy SC/APC
Port, quantity	9
Reverse Port Type	Hardened multi-fiber (HMFOC) jack, male/pinned
Reverse Port, quantity	1
Splitter, quantity	1
Stub Type	Hardened multi-fiber (HMFOC) plug, female/no pin

Dimensions

Height	80 mm 3.14 in
Width	128 mm 5.03 in
Length	207 mm 8.14 in
Cable Length, stub	2000 ft (609 m)
Cable Outer Diameter	4.3 x 8.0 mm (0.17 x 0.31 in) in

Dimension Drawing

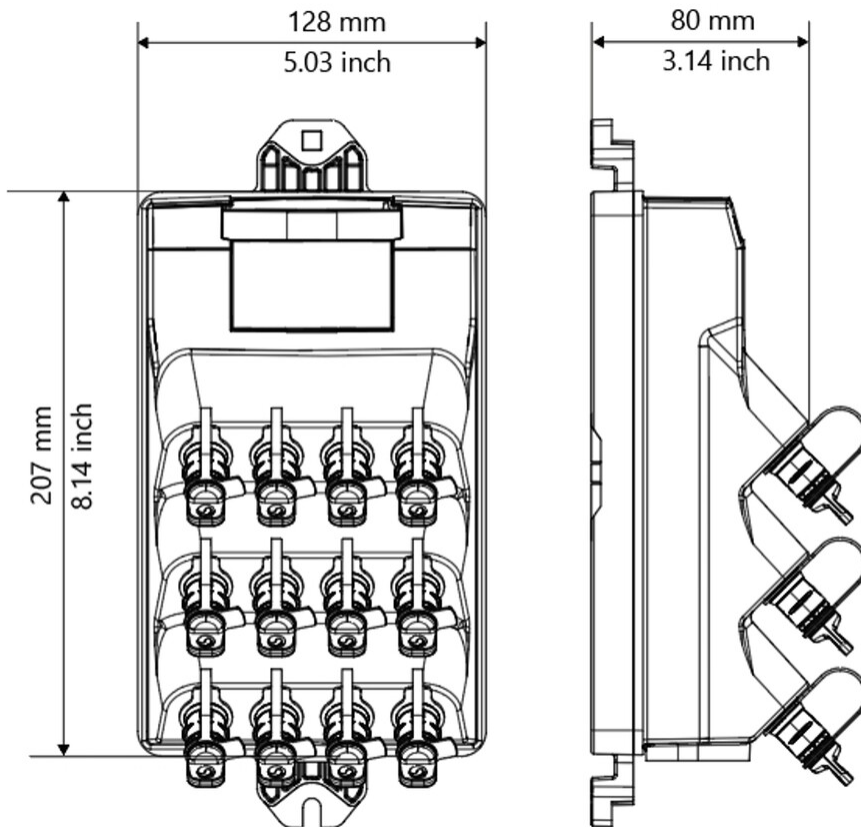

HXT-B9ARA2000FU000

Port Configuration

NOVUX HT	TECHNOLOGIES AVAILABLE	SMALL	MEDIUM	LARGE
HXT Series	Fiber Indexing	12 fiber index only, 1f	12 fiber 1:4	12 fiber 1:8
		12 fiber index only, 2f	12f multi-use 2f + 1:4	12 fiber multi-use, 3f + 1:4
		12 fiber index only, 3f	24f multi-use 2f	12 fiber multi-use, 4f + 1:4
		12 fiber index only, 4f	24f multi-use 3f	12 fiber multi-use, 2f + 1:8
		12 fiber multi-use, 2f	24f multi-use 4f	
		12 fiber branching, 2 to 6f per port		

Ordering Tree



Material Specifications

Enclosure Material Type Hardened plastic

Optical Specifications

Fiber Type G.657.A1/A2

Operating Wavelength Range 1260 – 1635 nm

Attenuation Single Ports, maximum 7.5 dB

Attenuation Cable Coefficient, maximum 0.30 dB/km @ 1550 nm | 0.40 dB/km @ 1310 nm

HXT-B9ARA2000FU000

Insertion Loss, Splitter, maximum	7.1 dB
Insertion Loss, Stub Connector, maximum	0.65 dB
Return Loss, Connector, maximum	65 dB
Return Loss, Single Ports, minimum	55 dB

Environmental Specifications

Operating Temperature	-40 °C to +65 °C (-40 °F to +149 °F)
Relative Humidity	5%–100%, condensing
Environmental Space	Above ground Below ground
Qualification Standards	IEC 60529, IP68 + 2 m waterhead IEC 61753-1, category G
UV Resistance	UV stabilized

Packaging and Weights

Included	Universal mounting bracket
Packaging quantity	1
Packaging Type	Box Universal spool, cardboard: terminal is on top of the spool, stub deploys first

Regulatory Compliance/Certifications

Agency	Classification
CHINA-ROHS	Below maximum concentration value
ISO 9001:2015	Designed, manufactured and/or distributed under this quality management system
REACH-SVHC	Compliant as per SVHC revision on www.commscope.com/ProductCompliance
ROHS	Compliant
UK-ROHS	Compliant

