

SFG22-12-4-96



G22 High Capacity Sector Frame, 12.5 ft face, includes four 96 in pipes;
For patents, see www.cs-pat.com.

OBSOLETE

This product was discontinued on: **March 22, 2023**

Replaced By:

SFG22HD-12-4-96

G22HD High Capacity Sector Frame with 2 7/8in OD x 12.5ft face. Includes four 2 3/8in OD x 96in antenna pipes.

Product Classification

Product Type High capacity Tower sector frame

General Specifications

Application 4G LTE antenna/radio mount

Mounting Angle 60°, 203.2 mm (8 in) | Straight or tapered legs up to 203.2 mm (8 in) OD

Patent Number Patent pending

Pipe, quantity 4

Tower Taper Non-tapered | Tapered

Dimensions

Height 2,438.4 mm | 96 in

Face Width 3.81 m | 12.5 ft

Width 3,810 mm | 150 in

Pipe Length 2,438.4 mm | 96 in

Face Support Pipe Diameter 60.325 mm | 2.375 in

Mounting Diameter, maximum 218.44 mm | 8.6 in

Mounting Diameter, minimum 38.1 mm | 1.5 in

Pipe Outer Diameter 60.325 mm | 2.375 in

Stand-off Distance 1,193.8 mm | 47 in

SFG22-12-4-96

Outline Drawing

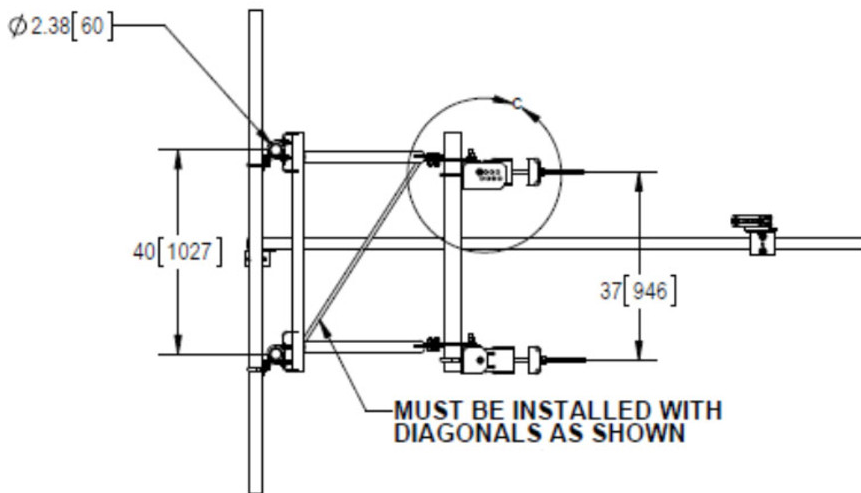
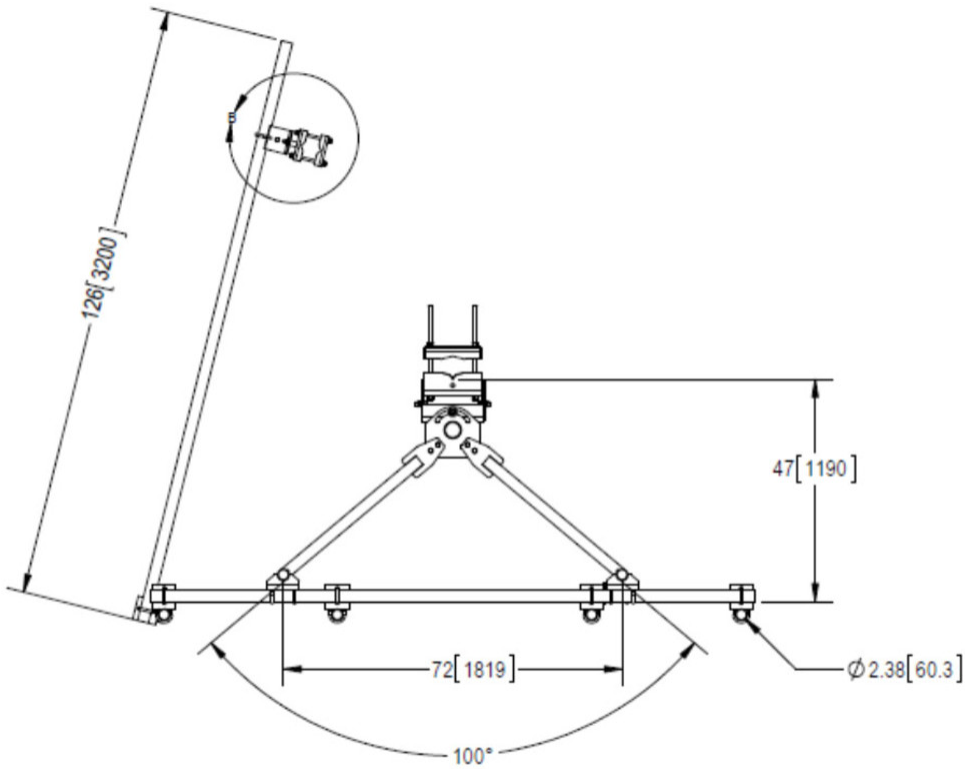

Material Specifications

Material Type

Hot dip galvanized steel

SFG22-12-4-96

Mechanical Specifications

Load Capacity	With additional stiff arm at 300 ft AGL: 600 lb per pipe w/out ice / 1775 lb per pipe including ice
Wind Rating	For Specifications, please contact your local ANDREW representative
Wind Rating Test Method	TIA/EIA-222-G
Wind Rating with Additional Stiff Arm	300 ft AGL: 120 mph (BWS) without ice /60 mph with ice

Packaging and Weights

Included	Frame Pipe mounts Plain end pipes (4) Stiff arm Tower attachment
Packaging quantity	1
Weight, net	233.555 kg 514.9 lb

Regulatory Compliance/Certifications

Agency	Classification
CHINA-ROHS	Above maximum concentration value
ISO 9001:2015	Designed, manufactured and/or distributed under this quality management system
ROHS	Compliant/Exempted
UK-ROHS	Compliant/Exempted



* Footnotes

Wind Rating	BWS—Base Wind Speed; FBC—Florida Building Code
Wind Rating with Additional Stiff Arm	BWS—Base Wind Speed; FBC—Florida Building Code